



# Flygt N-pump series

SELF-CLEANING PUMPS WITH SUSTAINED HIGH EFFICIENCY



# Sustained high efficiency is priceless



## The N-pump advantage

- Patented technology
- Innovative design
- Sustained high efficiency
- Self cleaning ability
- Modular design
- Reliable
- Fewer unplanned service calls

**Flygt N-pumps take on the toughest applications and get the job done. Every component is designed and manufactured to deliver sustained high efficiency. Thanks to patented N-technology with its innovative self-cleaning impeller, Flygt N-pumps deliver the highest total efficiency. It lowers your energy bill and reduces unplanned maintenance costs. That adds up to total peace of mind - and big savings over the long term.**

Our vast fluid handling knowledge and dedication to research and development leads to technological advances and continuous improvement.

That's why our Flygt N-pumps are at work in more than a hundred thousand installations worldwide. They have proven, by far, to be the best and most reliable choice for both dry and submersible installations.

## Robust and reliable

Every Flygt N-pump is tested in the factory to ensure high performance and premium quality. Flygt products deliver outstanding, cost-effective performance that has been proven in applications such as:

- Wastewater
- Raw water
- Cooling water
- Sludge
- Storm water
- Industrial effluent



## Broad range capacity

- Ratings from 1.3 kW to 310 kW
- Flow up to 1,000 l/s
- Heads up to 100 m
- Submersible and dry installations
- Every Flygt pump is performance tested in the factory

# Self-cleaning N-pump saves money

## Sustained high efficiency

When solid object such as stringy fibrous material and modern trash, enter the inlet of a conventional pump, they tend to get caught on the leading edges of the impeller vanes. This build-up reduced the impeller's efficiency, resulting in increased power consumption (Fig. A). This increased rate of power consumption generates an increase in energy charges.

As solids continue to build-up inside the impeller, motor thermal protection can trip causing the pump to stop. This leads to costly unplanned service calls.

If a conventional wastewater pump runs intermittently, the solids build-up will be removed by backflushing when the pump is shut off at the end of the operating cycle. When next cycle begins, efficiency returns to its initial value since the impeller is free from solid objects (Fig B).

The high efficiency of the Flygt N-pump is sustained over time due to its self-cleaning ability, keeping energy costs to a minimum (Fig. C).

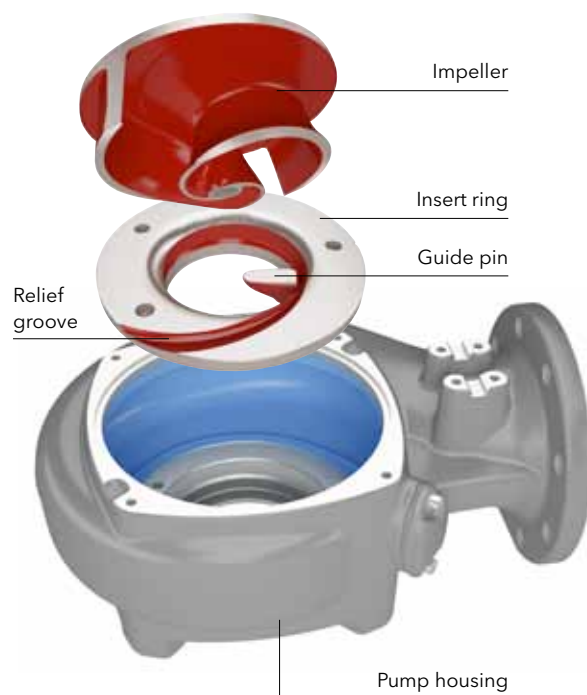

A. Conventional wastewater pump

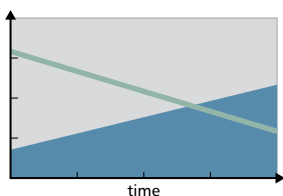

B. Conventional pump running intermittently

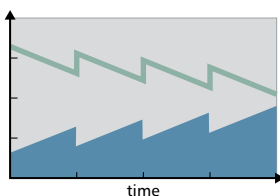

C. Flygt N-pump

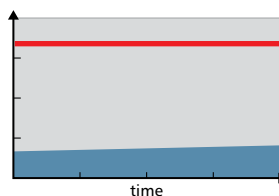

— Hydraulic efficiency  
— Sustained high efficiency  
— Energy consumption

## The self-cleaning concept

All Flygt N-pumps have the same self-cleaning performance regardless of duty point.



**Stage 1.** Most solid objects entering the pump will pass through the impeller between the impeller vanes. If an object gets caught on the leading edge of one of the vanes, it will slide along the backswept shape towards the perimeter of the inlet.



**Stage 2.** The solid object will slide along the tip of the impeller vane inside the relief groove. The guide pin in the insert ring will push all types of solids away from the center of the impeller, along the leading edge and out through the relief groove.

# Broad capacity range to suit your application

## Flexible and modular design

Flygt N-technology enables you to tailor the hydraulics to meet the requirements of virtually any application. Choose the hardened cast iron version for typical wastewater applications and the chopper ring version for cutting long fibres or solids. The Hard-Iron™ version should be used in abrasive applications and waters that could cause erosion corrosion due to high oxygen content.

Whatever you choose, you never sacrifice pump efficiency – and you can easily switch the module if the operating conditions change.

Cast iron



Cast iron impeller with hardened edges and insert ring for typical pumping applications.

Hard-Iron™ (60 HRC)



Extra durable option for abrasive and erosion corrosion applications.

Chopper ring for cutting long fibres or solids.

## Top performance with a broad capacity range

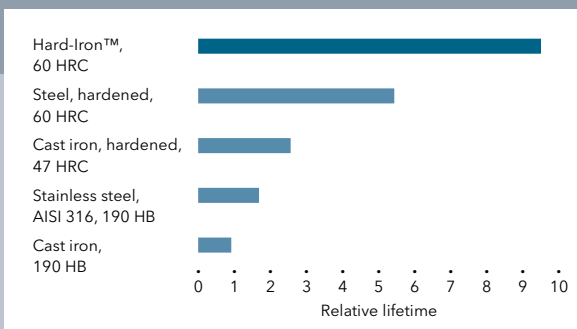
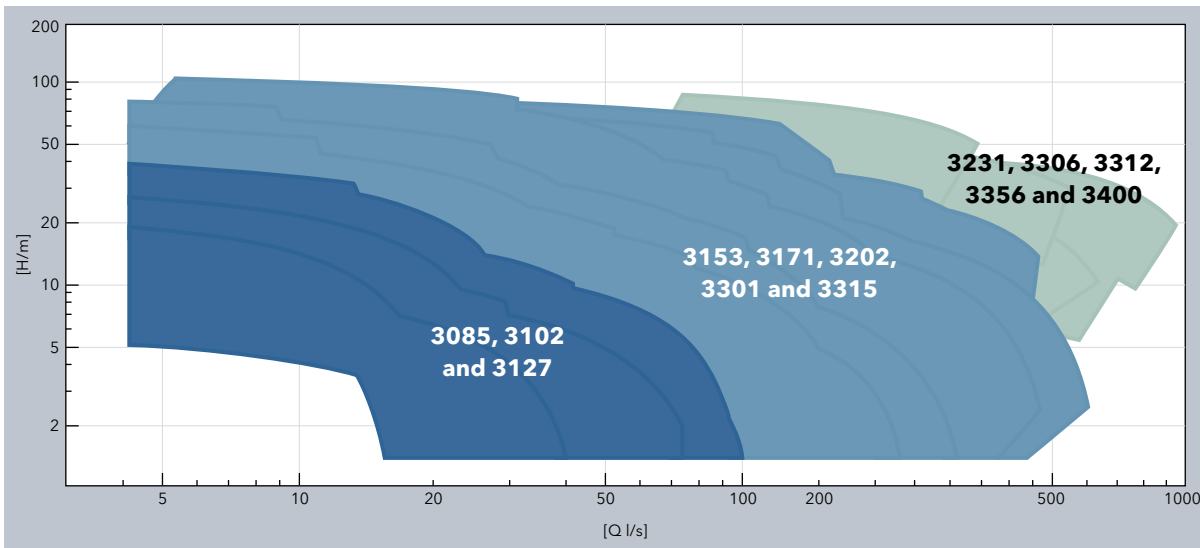

## Hard-Iron™ (60 HRC) for the toughest wastewater challenges

Accelerated wear tests prove that Hard-Iron™ hydraulic components keep on working efficiently with minimal wear after pumping water with a very high concentration of coarse sand (2,400 tons).

Flygt N-pumps with Hard-Iron™ components continue to deliver sustained high efficiency without clogging or erosion corrosion, prolonging lifetime by 200 percent compared to standard hardened cast iron hydraulics.

# Designed and engineered for longer life

Xylem specially designs and manufactures Flygt N-pump components, such as the motor, seals and shaft, to optimize operation and prolong pump service life.

## Motor

The Class H squirrel-cage induction motor delivers outstanding performance and superior heat transfer in submersible and dry installations. Heat losses are concentrated around the shrink-fitted stator, which is cooled by means of the surrounding water. The motor has a NEMA Class B maximum operating temperature rise of 80°C (176°F) to ensure long service life. Prepared for variable speed operation, all motors are capable of fully utilizing the available power.

## Long-life seals

Durable tungsten carbide seals offer exceptional mechanical strength as well as superior sliding properties even when running dry. These low-friction seals withstand thousands of hours of high-pressure operation under extreme conditions without cracking, seizing up or showing signs of unacceptable wear.

## Low shaft deflection

To minimize vibration, promote quiet operation and prolong seal and bearing life, all Flygt N-pumps feature a short shaft overhang to reduce shaft deflection.

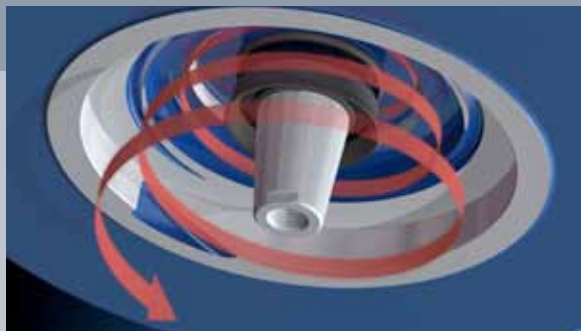

## Spin-out™ seal protection for pumps with cavities in the seal chamber

The patented Spin-out™ design expels abrasive particles from the seal chamber, providing protection against wear of the outer seal. As an integral part of the seal chamber, Spin-out™ is as simple as it is effective.

# Low capacity pumps

This series of Flygt N-pumps includes three models that handle capacities up to 100 l/s. Like all Flygt N-pumps, these contribute to reducing the total life cycle costs of your installation.



Performance, 50 Hz

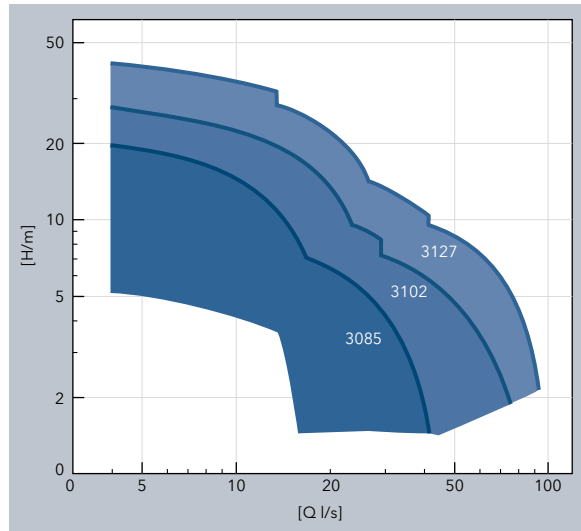

## Power ratings and sizes

Model	3085	3102	3127
Rating, kW	1.3-2.4	3.1-4.2	4.7-7.4
Discharge, mm (in)	80 (3")	80 (3") 100 (4") 150 (6")	80 (3") 100 (4") 150 (6")

## Methods of installation

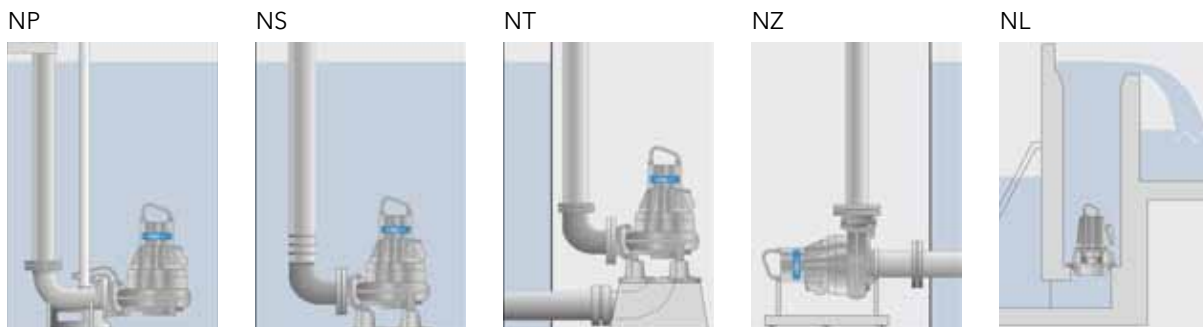

**NP**  
For semi-permanent wet well installations. The pump is installed with twin guide bars on a discharge connection.

**NS**  
A semi-permanent free standing installation. Transportable version with pipe or hose connection.

**NT**  
A vertically-mounted, permanent dry well or in-line installation with flange connections for suction and discharge pipework.

**NZ**  
A horizontally-mounted, permanent dry well or in-line installation with flange connections for suction and discharge pipework.

**NL**  
A semi-permanent installation of a pump within a vertical steel or concrete column.



**BETTER HEAT TRANSFER**

Our specially designed and manufactured motor provides enhanced cooling because heat losses are concentrated around the stator. Trickle impregnated in resin (Class H insulation), the stator windings are rated at 180°C (355°F) and enable up to 30 starts per hour.

**COMPLIANCE**

Each pump is tested and approved in accordance with national and international standards, including IEC 34-1 and CSA. Pumps are available in explosion-proof versions for use in hazardous environments, and are approved by the Factory Mutual, European Standard and IEC.

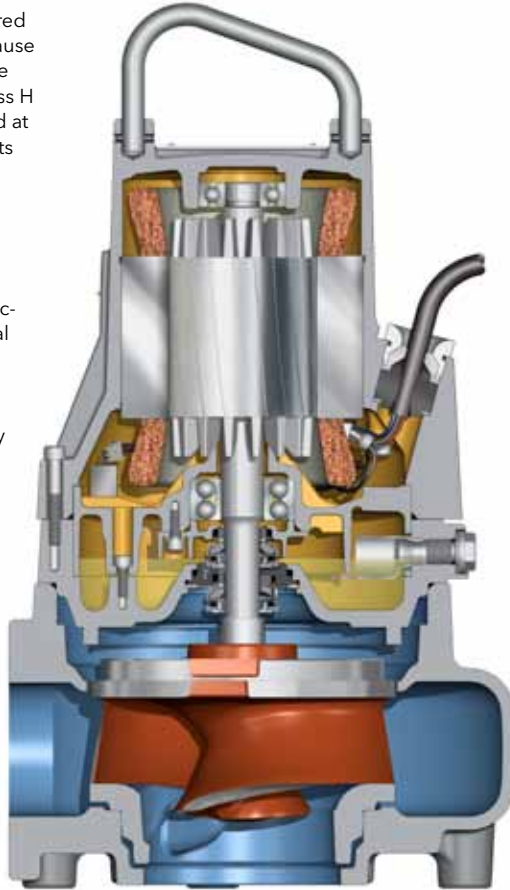

**CABLE ENTRY**

Water-resistant cable entry provides both sealing and strain relief functions to ensure a safe installation.

**SENSORS**

Thermal sensors embedded in the stator windings prevent overheating. Optional leakage sensors in the stator and oil housings are also available.

**LONG-LIFE BEARINGS**

Durable bearings provide a minimum service life of 50,000 hours.

**ENDURING SEALS**

The Griploc™ system consists of two sets of mechanical shaft seals that operate independently to provide double security against leakage.

**Griploc™ seal**

With a robust design, Griploc™ seals offer consistent performance and trouble-free operation in challenging environments. Solid seal rings minimize leakage and the patented griplock spring, which is tightened around the shaft, provides axial fixation and torque transmission. In addition, the Griploc™ design facilitates quick and correct assembly and disassembly.



**Adaptive N-impeller**

The Flygt N3085 features an adaptive self-cleaning N-impeller that can move axially to enable easy passage of large solids through the pump.

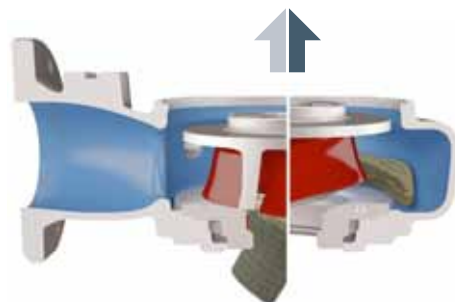

# Medium capacity pumps

For demanding pumping duties, five models handle fluid transport for capacities up to 500 l/s. Highly efficient, these heavy-duty models provide clog-free performance in order to achieve the best overall life cycle cost.



Performance, 50 Hz

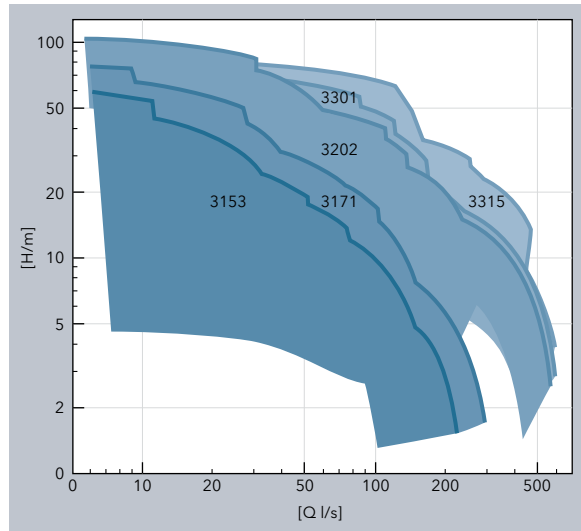

## Power ratings and sizes

Model	3153	3171	3202	3301	3315
Rating, kW	7.5-15	15-22	22-47	37-70	55-105
Discharge, mm (in)	80 (3")	100 (4")	100 (4")	150 (6")	150 (6")
	100 (4")	150 (6")	150 (6")	250 (10")	250 (10")
	150 (6")	250 (10")	200 (8")	300 (12")	300 (12")
	200 (8")		300 (12")	350 (14")	350 (14")
	250 (10")				

## Methods of installation

NP

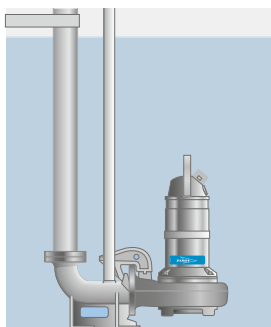

For semi-permanent wet well installations. The pump is installed with twin guide bars on a discharge connection.

NS

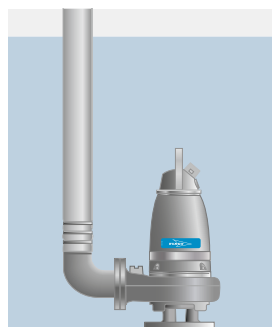

A semi-permanent free standing installation. Transportable version with pipe or hose connection.

NT

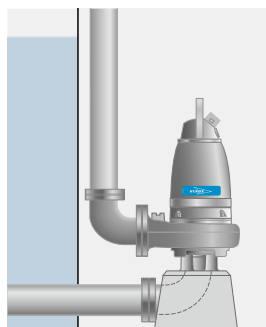

A vertically-mounted, permanent dry well or in-line installation with flange connections for suction and discharge pipework.

NZ

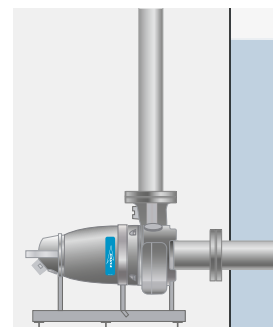

A horizontally-mounted, permanent dry well or in-line installation with flange connections for suction and discharge pipework.



**BETTER HEAT TRANSFER**

Our specially designed and manufactured motor provides enhanced cooling because heat losses are concentrated around the stator. Trickle impregnated in resin (Class H insulation), the stator windings are rated at 180°C (355°F) and enable up to 30 starts per hour.

**EFFICIENT COOLING**

These pumps are cooled either by the surrounding liquid or, in more demanding applications, with an internal closed-loop cooling system.

**INSPECTION CHAMBER**

To increase operational reliability, an inspection chamber between the seal unit and the bearings enables rapid spot checks and maintenance. In the case of a seal failure, a built-in sensor provides an early warning of any fluid build-up, thus reducing the risk of expensive repair work.

**COMPLIANCE**

Each pump is tested and approved in accordance with national and international standards, including IEC 34-1 and CSA. Pumps are available in explosion-proof versions for use in hazardous environments, and are approved by the Factory Mutual, European Standard and IEC.

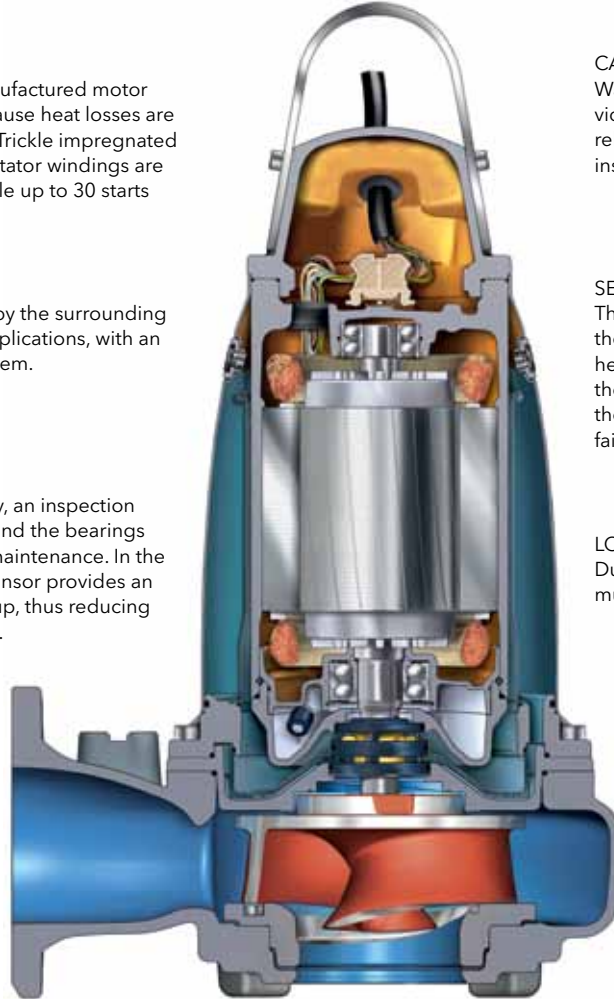

**CABLE ENTRY**

Water-resistant cable entry provides both sealing and strain relief functions to ensure a safe installation.

**SENSORS**

Thermal sensors embedded in the stator windings prevent overheating, and a leakage sensor in the inspection chamber minimizes the risk for bearing and stator failure.

**LONG-LIFE BEARINGS**

Durable bearings provide a minimum service life of 50,000 hours.

**ENDURING SEALS**

The Flygt Plug-in™ seal with the Active Seal™ system offers increased sealing reliability and zero leakage into the motor, thereby reducing the risk of bearing and stator failure.

**Flygt Plug-in™ seal with Active Seal™ system**

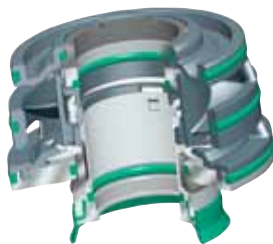

Inner seal with laser-cut spiral grooves.



The Flygt Plug-in™ seal is a seal unit that eliminates the risks associated with incorrect installation and careless handling. It comprises the Active Seal™ system in one easy-to-handle unit.

The Active Seal™ system is a patented zero-leakage double-seal system that actively prevents liquid from entering the motor cavity, thereby reducing the risk for bearing and stator failure. It comprises a unique inner seal that acts as a micro-pump and an outer seal that prevents leakage of pumped media into the buffer chamber.

Laser-cut grooves on the inner seal create a hydrodynamic pumping effect that prevents any leakage from entering the motor.

This translates into enhanced sealing reliability, reduced downtime and fewer unscheduled maintenance checks. In addition, regular service inspections can be prolonged in many applications.

# Large capacity pumps

When higher capacity is required, the Flygt N-pump series has five pumps to do the job. These models deliver unprecedented pumping power - reliably and efficiently.



Performance, 50 Hz

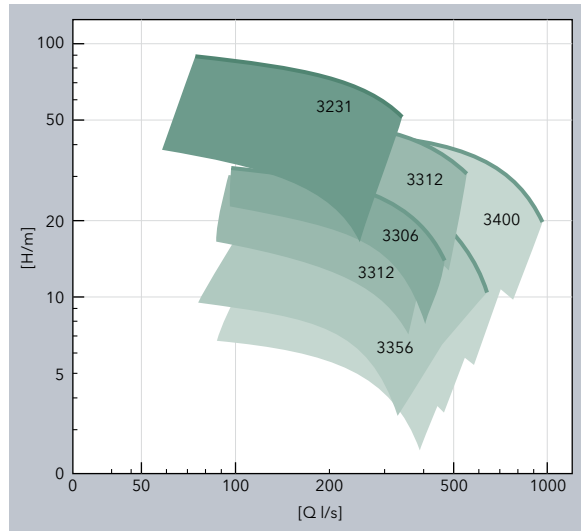

## Power ratings and sizes

Model	3231	3306	3312	3356	3400
Rating, kW	70-215	58-100	55-250	45-140	40-310
Discharge, mm (in)	200 (8")	300 (12")	300 (12")	350 (14")	400 (16")

## Methods of installation

NP



For semi-permanent wet well installations. The pump is installed with twin guide bars on a discharge connection.

NS



A semi-permanent free standing installation. Transportable version with pipe or hose connection.

NT



A vertically-mounted, permanent dry well or in-line installation with flange connections for suction and discharge pipework.

NZ



A horizontally-mounted, permanent dry well or in-line installation with flange connections for suction and discharge pipework.

**BETTER HEAT TRANSFER**

Our specially designed and manufactured motor provides enhanced cooling because heat losses are concentrated around the stator. Trickle impregnated in resin (Class H insulation), the stator windings are rated at 180°C (355°F) and enable up to 15 starts per hour.

**COMPLIANCE**

Each pump is tested and approved in accordance with national and international standards, including IEC 34-1 and CSA. Pumps are available in explosion-proof versions for use in hazardous environments, and are approved by the Factory Mutual, European Standard and IEC.

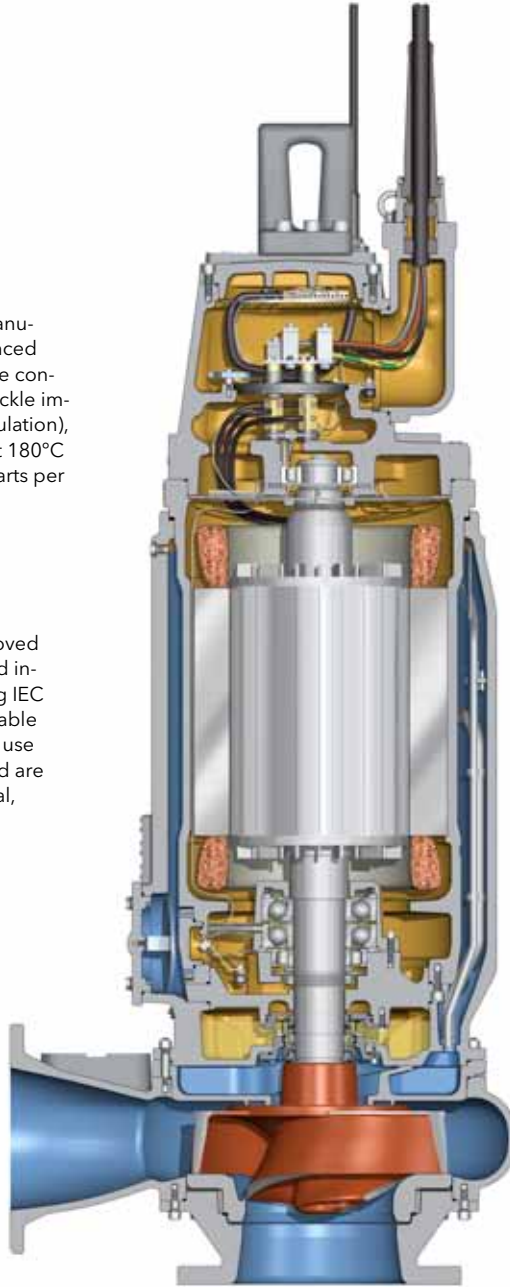

**CABLE ENTRY**

Water-resistant cable entry provides both sealing and strain relief functions for a safe installation.

**SENSORS**

Thermal sensors in the stator windings prevent overheating, and an analogue temperature sensor monitors the lower bearing. The stator housing and the junction box are equipped with leakage sensors. The sensors decrease the risk of bearing and stator failure.

**LONG-LIFE BEARINGS**

Durable bearings provide a minimum service life of 100,000 hours.

**ENDURING SEALS**

Two sets of mechanical shaft seals work independently for double security. The Active Seal™ system offers increased sealing reliability and zero leakage into the motor, thereby reducing the risk of bearing and stator failure.

**Zero leakage into the motor cavity**



The Active Seal™ system is a patented zero-leakage double-seal system that actively prevents liquid from entering the motor cavity, thereby reducing the risk for bearing and stator failure. It comprises a unique inner seal that acts as a micro-pump and an outer seal that prevents leakage of pumped media into the buffer chamber.

Laser-cut grooves on the inner seal create a hydrodynamic pumping effect that prevents any leakage to enter the motor.

This translates into enhanced sealing reliability, reduced downtime and fewer unscheduled maintenance checks. In addition, regular service inspections can be prolonged in many applications.

# Complete solutions for your needs



## Ready-to-install prefabricated pump stations

Flygt N-pumps can be delivered ready to install in standard, prefabricated pump stations with everything you need. Our prefabricated pump stations feature the most reliable and cost-effective pumping solutions. Our solutions are pre-assembled with

your configuration of valves, discharge pipe, and inlet and outlet connections. Installation and start-up is easy and requires minimal time.



Flygt MiniCAS

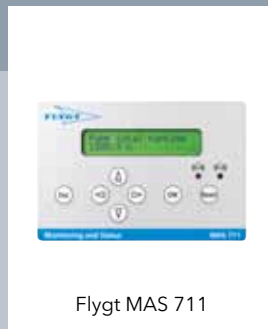

Flygt MAS 711

## Monitoring and control: Empower your business

**Flygt MiniCAS** is a supervision relay for stator temperature and leakage sensors designed for low and medium capacity Flygt N-pumps.

**Flygt MAS 711** is a protective monitoring system for medium and large capacity Flygt N-pumps.





### Engineered solutions

Flygt N-pumps can be configured to your specific requirements. Our engineers work closely with you, from design and system analysis to selection of product and installation equipment. This enables us to deliver reliable and cost-effective pumping solutions.

Perfect compliance. All Flygt monitoring and control equipment integrates easily into any **SCADA** control system.



### Flygt N-pumps: Submersible and dry installations

Flygt N-pumps are an excellent choice for handling solids in dry-pit installations. Originally designed for submersible conditions, our pumps eliminate the risk of damage to the motor due to station flooding. Submersible or dry-installed Flygt N-pumps deliver superior clog-free operation with minimal maintenance and substantial energy savings.

# The power to adapt

## Options table

Customize your Flygt N-pump with optional equipment.

Flygt N-pump model	3085	3102	3127	3153	3171	3202	3301	3315	3231	3306	3312	3356	3400
<b>Option/Product</b>													
<b>Hydraulic</b>													
Guidepin	●	●	●	◐	◐								
Hard-Iron™	○	○	○	○	○	○	○		○				
Chopper			○	◐	◐	◐							
Adaptive N	◐	◐	◐										
<b>Seal system</b>													
Griploc™ seal	●	●	●										
Plug-in™ seal				●	●	●	●	●					
Active Seal™				●	●	●	●	●	●	●	●	●	●
Spin-out™	●	●	●	●	●	●	●	●	◐	◐	◐	◐	◐
Seal flush									○	○	○	○	○
<b>Cooling system</b>													
1. No cooling	●	●	●	●	●	●	●	●	●	●	●	●	●
2. Internal				○	○	○	○	○					
3. Integrated									○	○	○	○	○
4. External				○	○	○	○	○	○	○	○	○	○
<b>Installation</b>													
NP	●	●	●	●	●	●	●	●	●	●	●	●	●
NS	●	●	●	●	●	●	●	●	●	●	●	●	●
NT	●	●	●	●	●	●	●	●	●	●	●	●	●
NZ	●	●	●	●	●	●	●	●	●	●	●	●	●
NL		●	●										
<b>Accessories</b>													
Flush valve	○	○	○	◐	◐	◐	◐	◐					
<b>Pump monitor</b>													
<i>Prepared for</i>													
- Mini CAS	●	●	●	●	●	●	●	●					
- MAS					○	○	○	○	●	●	●	●	●

- = Standard
- = Optional
- ◐ = Standard but also optional depending on model
- ◑ = Standard or not available depending on model
- ◒ = Optional or not available depending on model

## Self cleaning saves money

Schematic overview of calculations made on a 30kW pump.

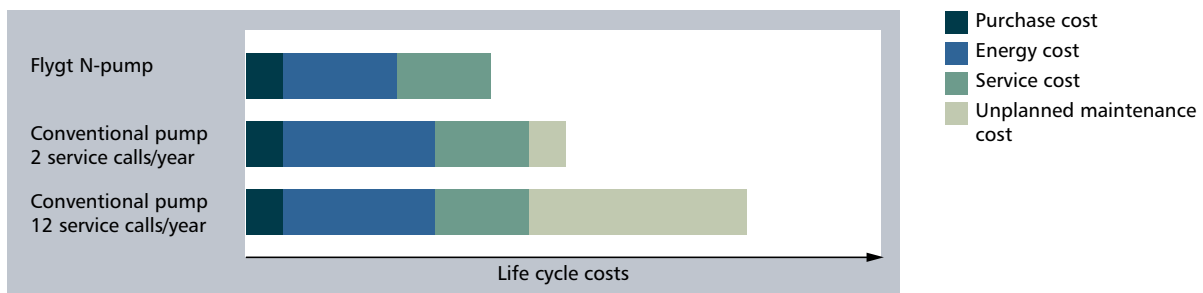



# Supporting your business, every step of the way



## Extensive monitoring and control

We supply hardware and software for complete process systems - from individual pump drives, starters, sensors and controllers to system software and scalable **SCADA** systems.



## Genuine Flygt spare parts and warranty

When downtime isn't an option, rely on our global service network to deliver genuine Flygt spare parts to you - quickly and efficiently. All Flygt spare parts are backed by a solid 15-year availability guarantee. Large capacity pumps even 20-year.

## Extensive engineering know-how

Xylem has extensive knowledge of fluid dynamics and vast practical experience in designing, operating and maintaining efficient wastewater transport systems.

We provide a broad range of engineering services, including:

- System analysis and calculations
- Sump design
- Water hammer calculations
- Pump start analysis
- Transient analysis
- Computational Fluid Dynamics (CFD)
- Scale model testing

In short, we can assist you with everything you need for optimal performance and economical, energy-efficient operation.

## Empower your system

With Flygt monitoring and control products, you can control and optimize the performance of every component of your system. This helps reduce stress on pumps, valves and mains, enable reliable, efficient operation and prolong service lifetime.

## Support for your Flygt pumps

Our global network of local service centers and service partners, provide integrated services to support safe, efficient and reliable operation. To ensure trouble-free operation and minimal downtime, count on us for quick, professional response and quality maintenance services, using genuine Flygt spare parts.

# Xylem ['zīləm]

- 1) The tissue in plants that brings water upward from the roots
- 2) A leading global water technology company

We're 12,000 people unified in a common purpose: creating innovative solutions to meet our world's water needs. Developing new technologies that will improve the way water is used, conserved, and re-used in the future is central to our work. We move, treat, analyze, and return water to the environment, and we help people use water efficiently, in their homes, buildings, factories and farms. In more than 150 countries, we have strong, long-standing relationships with customers who know us for our powerful combination of leading product brands and applications expertise, backed by a legacy of innovation.

For more information on how Xylem can help you, go to [xylem.com](http://xylem.com).



## **BAO BINH TECHNOLOGY CO., LTD**

Address: 816/20 Truong Sa, Ward 14, District 3, HCMC, Vietnam.

Tel. +84 28 38420440 Fax. +84 28 38420460

[www.bbtec.com.vn](http://www.bbtec.com.vn)



Flygt is a brand of Xylem. For the latest version of this document and more information about Flygt products visit [www.flygt.com](http://www.flygt.com)